

NOTES:

1. SAMPLE RENDERING ONLY
2. TOTAL DISPLAY WEIGHT: APPROXIMATELY 60 LBS [27.2 KG]
3. ALL ATTACHMENT HARDWARE TO BE ORDERED SEPARATELY
4. DIMENSIONS ARE APPROXIMATE AND SUBJECT TO CHANGE DUE TO DETAILED DESIGN CONSIDERATIONS
5. ALL CONSTRUCTION AND FABRICATION MUST MEET ALL APPLICABLE LOCAL, STATE, AND NATIONAL CODES
6. ALL ON-SITE WORK TO BE DONE IN ACCORDANCE WITH OSHA AND ALL LOCAL CODES THAT APPLY
7. CTS ASSUMES NO RESPONSIBILITY FOR INSTALLATIONS PERFORMED BY OTHERS

A1	EDIT SCOREBOARD P/N	09/22/15	PJS
REV	DESCRIPTION	DATE	APP

THE INFORMATION ON THIS DRAWING IS SUBJECT TO CHANGE WITHOUT NOTICE

**WWW.COLORADOTIME.COM**

**REVISIONS**

THIRD ANGLE PROJECTION

**TRADE SECRET**

The information and data contained herein is secret and is submitted in confidence, and shall not be disclosed, used, or duplicated for any purpose whatsoever without the prior written permission of Colorado Time Systems, Inc., 1551 E. 11th Street, Loveland Colorado, 80537. This legend shall be marked on any reproduction hereof in whole or in part. Receipt of this document shall be deemed to be an acceptance of the conditions specified herein.

DIMENSIONS ARE REPRESENTED AS FOLLOWS: INCH [MM]

TOLERANCES EXCEPT AS NOTED

INCHES	MM
X ± 0.02	X ±
ANGLES ± 1	
DO NOT SCALE THIS DRAWING	
SCALE	SHEET 1 OF 3

DRAWN BY	DATE
VWODEK B.	05/07/15
ENG. APPROVAL	DATE
PROJECT ENG.	DATE

TITLE
MS-0149 WALL MOUNT GENERAL LAYOUT



1551 E. 11th. St.  
Loveland, CO 80537  
P: (970) 667-1000  
F: (970) 667-5876  
WWW.COLORADOTIME.COM

SIZE	DRAWING NUMBER	REV.
B	S2015-002-006	A1

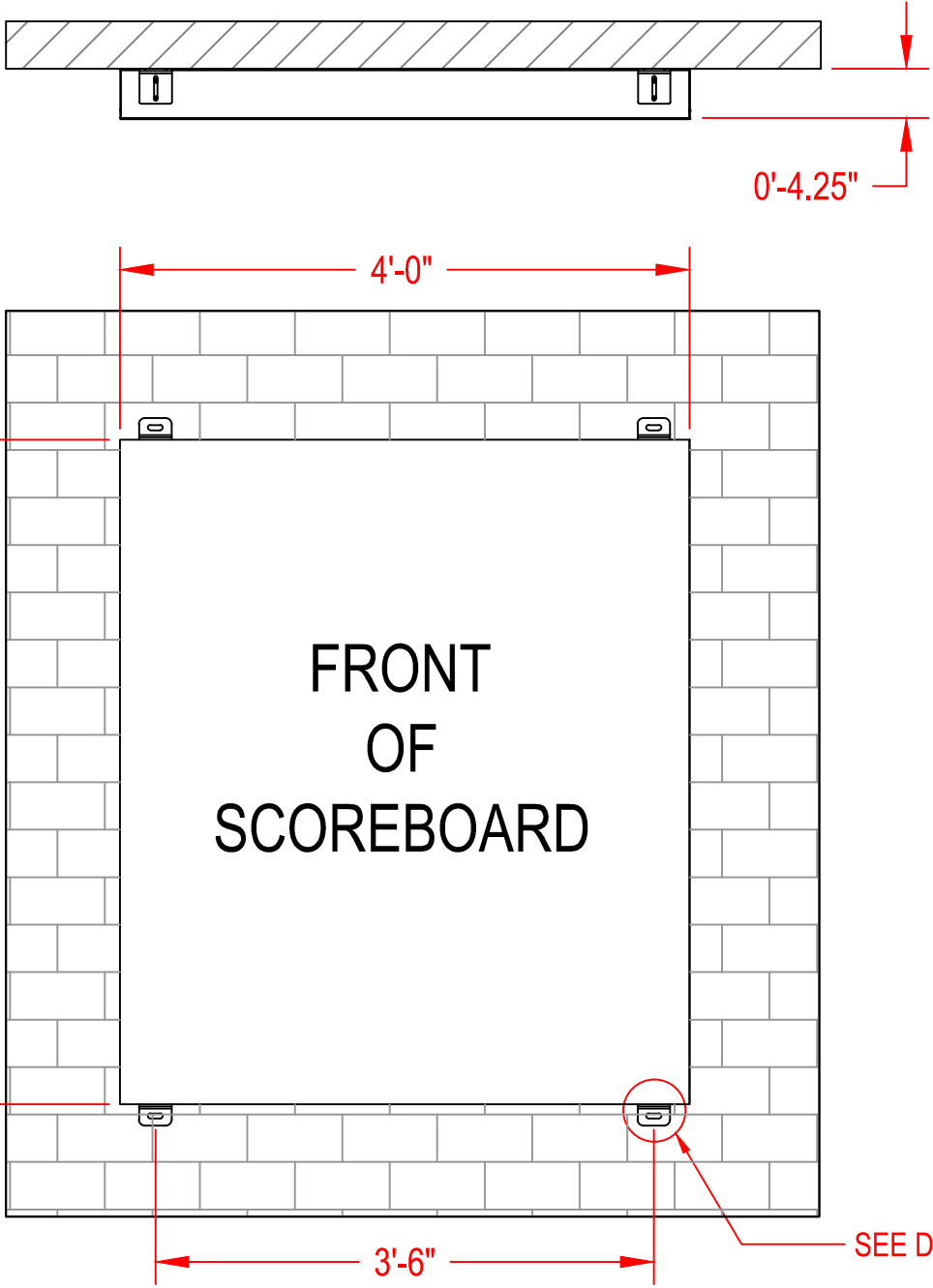

**INSTALLATION PROCEDURE:**

1. ATTACH (4) MOUNTING TABS TO SCOREBOARDS IN LOCATIONS SHOWN, USING 1/4" STAINLESS STEEL HARDWARE

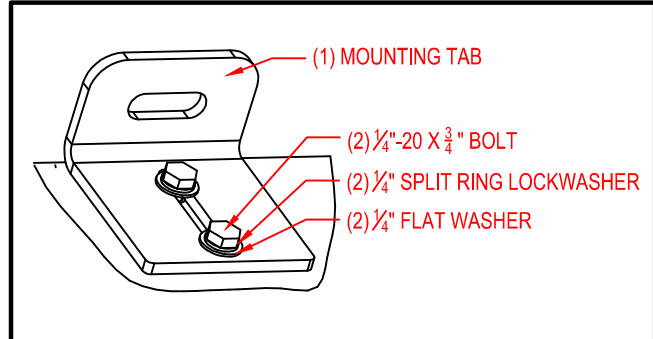

DETAIL A  
MOUNTING TAB- SCOREBOARD ATTACHMENT  
4 LOCATIONS TOTAL

2. SECURE MOUNTING TABS TO WALL/STRUCTURE USING REDHEAD (4) SHN-3817 3/8" X 1 7/8" STAINLESS STEEL SLEEVE ANCHORS OR SIMILAR -ENSURE DISPLAY IS LEVEL, PLUMB, AND SQUARE ON STRUCTURE

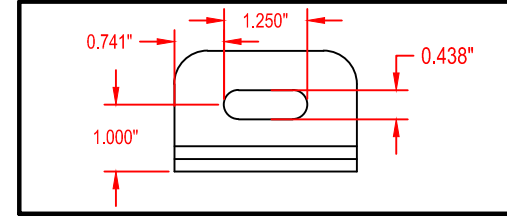

DETAIL B  
MOUNTING TAB- WALL ATTACHMENT  
4 LOCATIONS TOTAL

SEE DETAILS A & B

**WWW.COLORADOTIME.COM**

THE INFORMATION ON THIS DRAWING IS SUBJECT TO CHANGE WITHOUT NOTICE

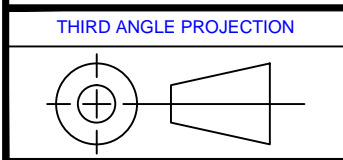

**TRADE SECRET**  
The information and data contained herein is secret and is submitted in confidence, and shall not be disclosed, used, or duplicated for any purpose whatsoever without the prior written permission of Colorado Time Systems, Inc., 1551 E. 11th Street, Loveland Colorado, 80537. This legend shall be marked on any reproduction hereof in whole or in part. Receipt of this document shall be deemed to be an acceptance of the conditions specified herein.

DIMENSIONS ARE REPRESENTED AS FOLLOWS: INCH [MM]	
TOLERANCES EXCEPT AS NOTED	
INCHES	MM
X ± 0.02	X ±
ANGLES ± 1	
DO NOT SCALE THIS DRAWING	
SCALE	SHEET 2 OF 3
NTS	

DRAWN BY	DATE
VWODEK B.	05/07/15
ENG. APPROVAL	DATE
PROJECT ENG.	DATE

TITLE
MS-0149
WALL MOUNT
STRUCTURAL DETAILS

SIZE	DRAWING NUMBER	REV.
B	S2015-002-006	A1

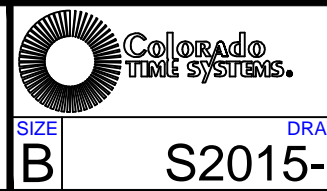

1551 E. 11th. St.  
Loveland, CO 80537  
P: (970) 667-1000  
F: (970) 667-5876  
WWW.COLORADOTIME.COM

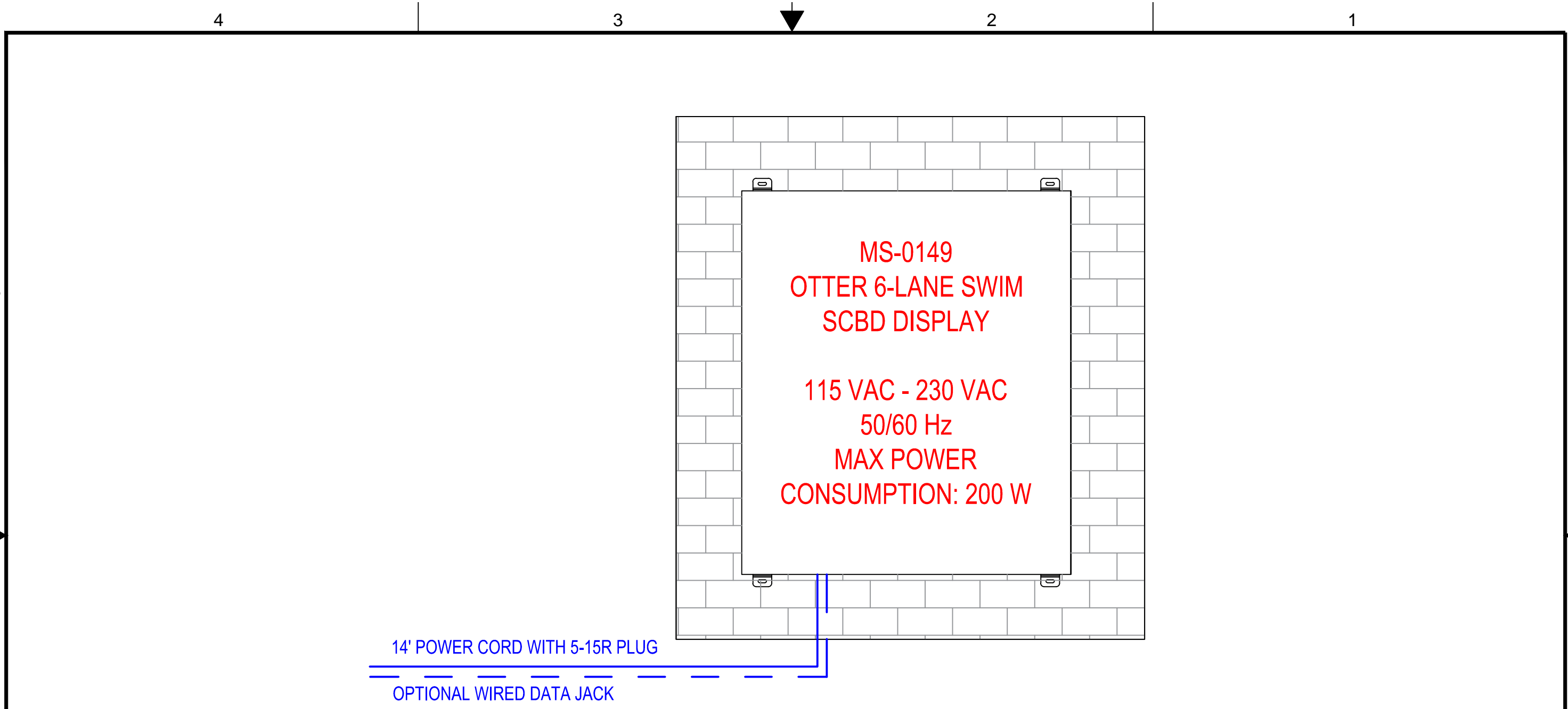

NOTES:

1. POWER AND DATA CABLES MUST BE ROUTED IN SEPARATE CONDUIT
2. CTS SUGGESTS 3/4" CONDUIT FOR ALL BURIED CABLE
3. EACH DISPLAY IS EQUIPPED WITH A 14' POWER CABLE WITH A NEMA 5-15R PLUG. NOTE THE EXIT LOCATION IS ON THE BOTTOM OF THE DISPLAY. THIS CABLE IS ONLY TO BE USED IN CONJUNCTION WITH AN OUTDOOR RATED RECEPTACLE
4. IF USING WIRED DATA, TERMINATE DATA CONDUIT TO JUNCTION BOX NEAR DATA JACK LOCATION
5. SCOREBOARD DOES NOT INCLUDE ON/OFF POWER SWITCH. INSTALL OPTIONAL SWITCH/DISCONNECT FOR ABILITY TO TURN SCOREBOARD ON/OFF IF NEEDED OR DESIRED
6. THIS SIGN IS INTENDED TO BE INSTALLED IN ACCORDANCE WITH THE REQUIREMENTS OF ARTICLE 600 OF THE NATIONAL ELECTRIC CODE AND/OR OTHER APPLICABLE CODES. THIS INCLUDES PROPER GROUNDING AND BONDING OF THE SCOREBOARD

THE INFORMATION ON THIS DRAWING IS SUBJECT TO CHANGE WITHOUT NOTICE

	<p><b>TRADE SECRET</b></p> <p><small>The information and data contained herein is secret and is submitted in confidence, and shall not be disclosed, used, or duplicated for any purpose whatsoever without the prior written permission of Colorado Time Systems, Inc., 1551 E. 11th Street, Loveland Colorado, 80537. This legend shall be marked on any reproduction hereof in whole or in part. Receipt of this document shall be deemed to be an acceptance of the conditions specified herein.</small></p>	<p>DIMENSIONS ARE REPRESENTED AS FOLLOWS: INCH (MM)</p>		<p>DRAWN BY</p> <p>VWODEK B.</p>	<p>DATE</p> <p>05/07/15</p>	<p>TITLE</p> <p>MS-0149 WALL MOUNT ELECTRICAL DETAILS</p>		<p>1551 E. 11th. St. Loveland, CO 80537 P: (970) 667-1000 F: (970) 667-5876 WWW.COLORADOTIME.COM</p>
		<p>TOLERANCES EXCEPT AS NOTED</p> <p>INCHES .02 X ±</p> <p>MM .X ±</p>	<p>ENG. APPROVAL</p> <p>PROJECT ENG.</p>	<p>DATE</p> <p>DATE</p>	<p>SIZE</p> <p>B</p>			

[WWW.COLORADOTIME.COM](http://WWW.COLORADOTIME.COM)